

POWER ELECTRONICS

****DC-DC Switching Power Regulation****
5V and 3.3V outputs are isolated from High Voltage, but not each other

Sheet: Isolated Power Supply

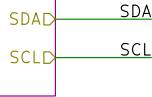

File: power.sch

FTDI USB UART

Sheet: FTDI USB UART

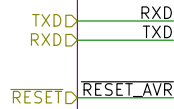

File: ftdi_uart.sch

SAFETY LOOP WIRING

Sheet: Safety Loop Wiring

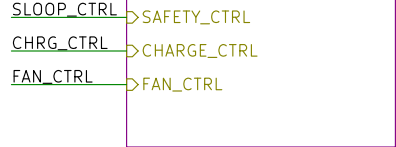

File: safety_loop.sch

CAN TRANCEIVER

Sheet: CAN Transceiver



File: can_xcvr.sch

CONNECTORS

Sheet: External Connectors

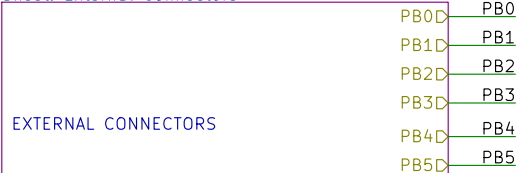

File: connectors.sch

AVR MICROCONTROLLER

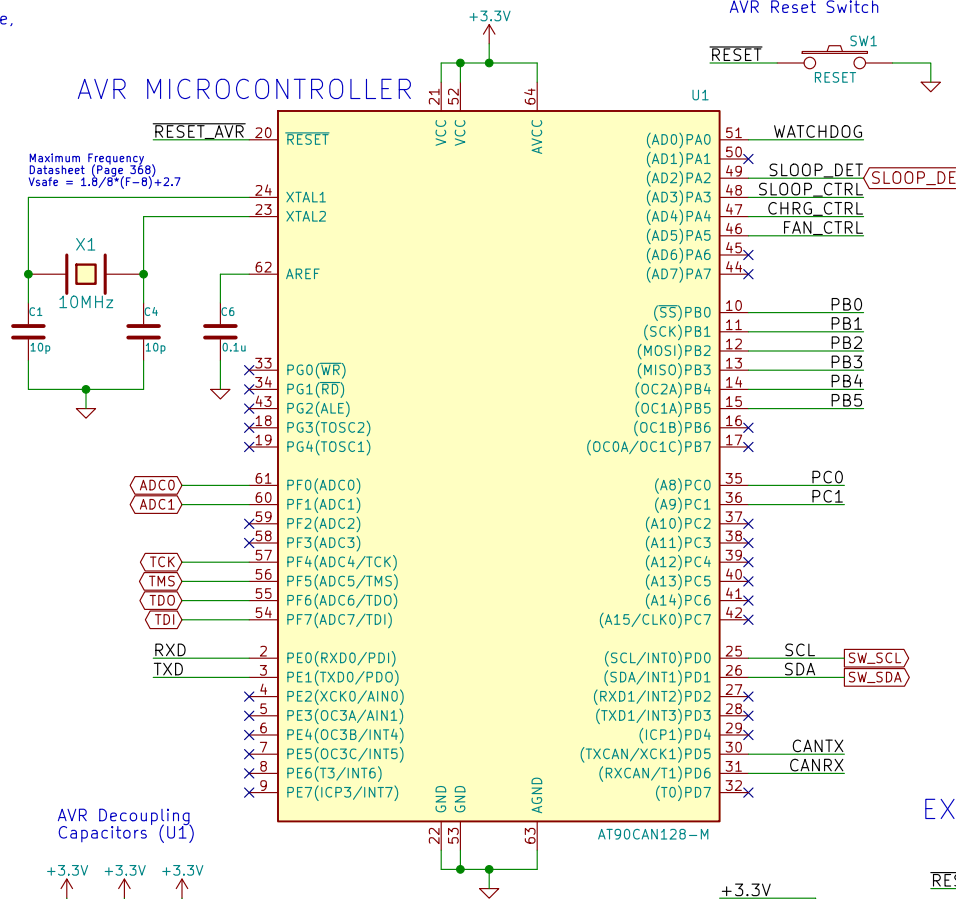

GROUNDING LOW VOLTAGE

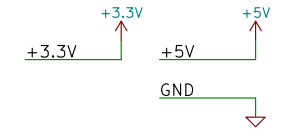

SYSTEM STATUS LEDs

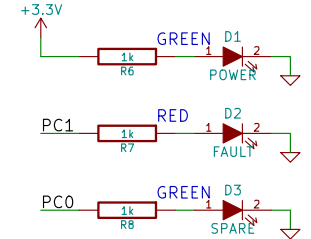

EXTERNAL WATCHDOG

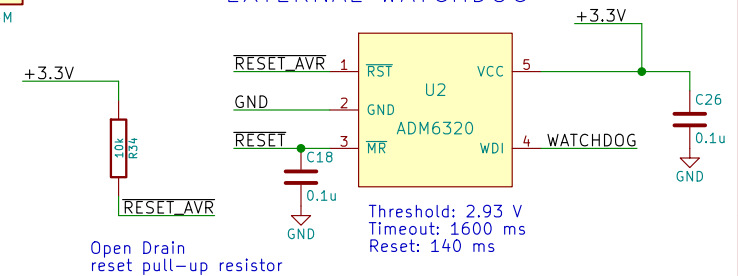

I2C PULLUP

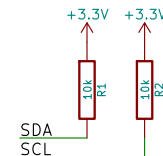

DEVELOPMENT ONLY

Engineer: Preston Bejabeng
Supervisor: Christopher Nadovich
Fall Semester 2016
Lafayette College

Sheet: /
File: pacman-main.sch

Title: Battery Pack Management Computer; L17-TSV-1

Size: USLetter Date: 2016-12-13
KiCad E.D.A. eeschema 4.0.2-stable

Rev: 0.8
Id: 1/6

HIGH VOLTAGE INTERFACES

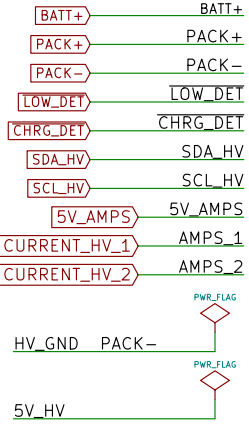

HIGH VOLTAGE POWER

This power supply is responsible for delivering non-isolated 5V power to the high voltage electronics. All AMS bus connected devices are powered from this regulator. Maximum current draw 250mA. This Switcher was selected for its high efficiency even at light load.

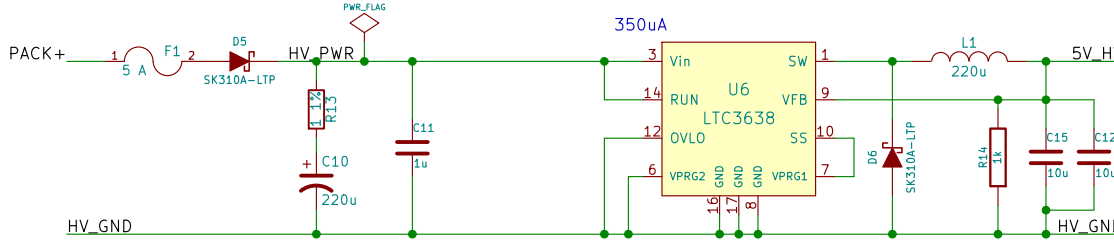

HIGH VOLTAGE



LOW VOLTAGE

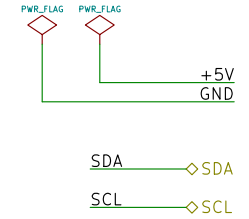

PACK VOLTAGE SENSOR AND CHARGE SENSOR

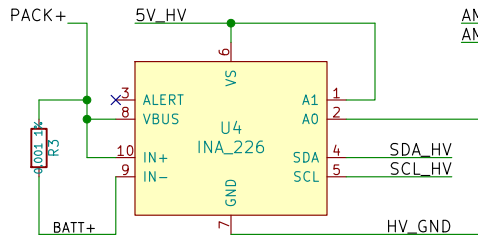

I2C Address 0x44 (see datasheet page 18) Additional documentation of the use of this component is req'd.

HIGH VOLTAGE DIGITAL I/O

This I/O expander is responsible for relaying digital signals across the HV-LV isolation barrier via the I2C bus.

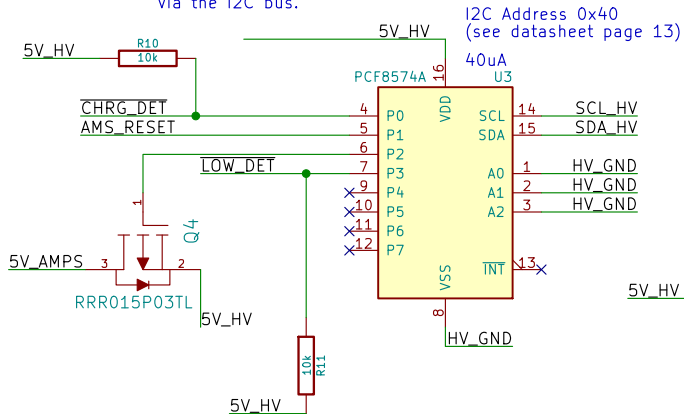

I2C Address 0x48 (see datasheet page 14)

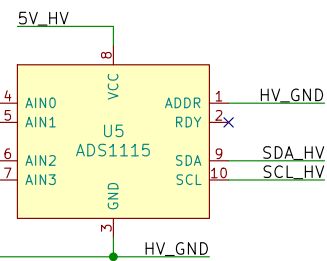

I2C PULLUP

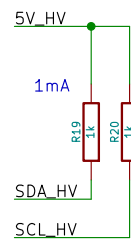

I2C ISOLATOR

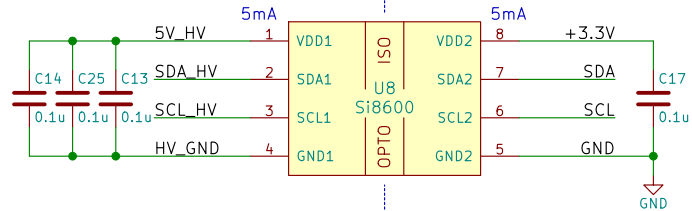

HIGH VOLTAGE LOW VOLTAGE

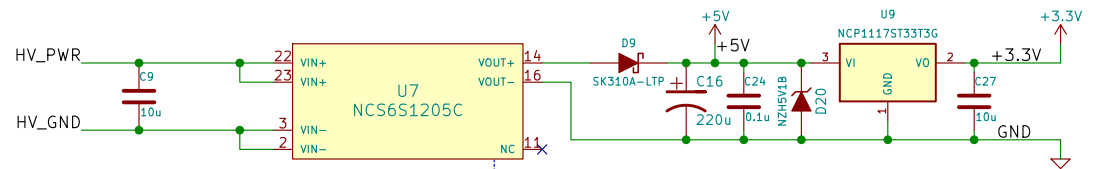

The flyback regulator responsible for delivering 5V isolated power to low voltage systems has been replaced with an isolated DC/DC converter. This is due to the insufficient output current (300mA) available when assembled. Cost is comparable.

Maximum Current Draw on 5V output: 1.2A

DEVELOPMENT ONLY
 Engineer: Preston Bejabeng
 Supervisor: Christopher Nadovich
 Fall Semester 2016

Lafayette College
 Sheet: /Isolated Power Supply/
 File: power.sch

Title: Battery Pack Management Computer; L17-TSV-1

Size: USLetter Date: 2016-12-13
 KiCad E.D.A. eeschema 4.0.2-stable

Rev: 0.8
 Id: 2/6



OPTO-ISOLATOR ON SL CLOSED SIGNAL

This device provides a galvanically isolated signal to the microcontroller to let it know the safety loop is closed in all components. The HV current sensor is enabled as a result. This means the AIRs should be closed if functional.

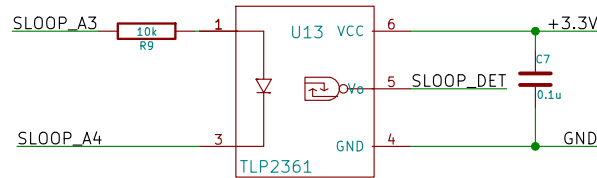

HIGH SIDE P-FET DRIVER

This device is responsible for driving the high side p-fet switches.

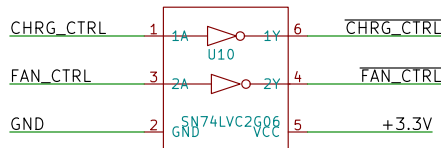

SAFETY LOOP RELAY

This relay is responsible for switching the PACMAN safety loop connection ON/OFF. The lights show the user at a glance if the safety loop is open or closed.

This relay is capable of switching 8A. The SLOOP_CTRL signal is active low.

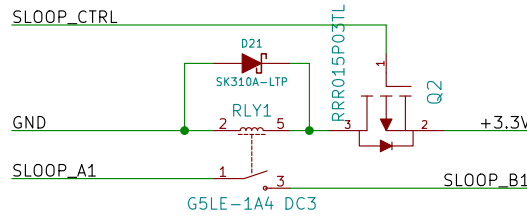

FAN CONTROL P-FET

This MOSFET is responsible for switching the charge fan ON/OFF.

The fan will not come on automatically when charging begins, it is controlled by the software.

Fan Output Voltage: 5V

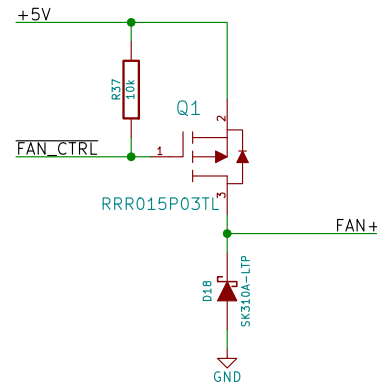

GROUNDING LOW VOLTAGE

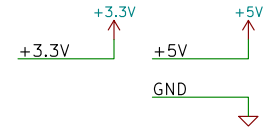

A1 and B1 pins are shorted together only when the safety loop is not opened by this board.

Voltage between A3 and A4 greater than 0 means the safety loop is not opened by any other component in the system.

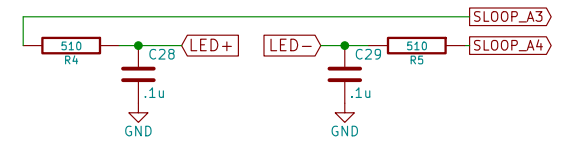
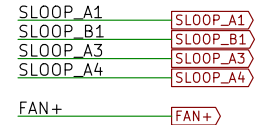

CHARGE CONTROL P-FET

This MOSFET is responsible for connecting the CHARGE relays when the pack charger has been connected. Power is supplied from either the pack terminals, or USB connector.

Coil Output Voltage: 5V

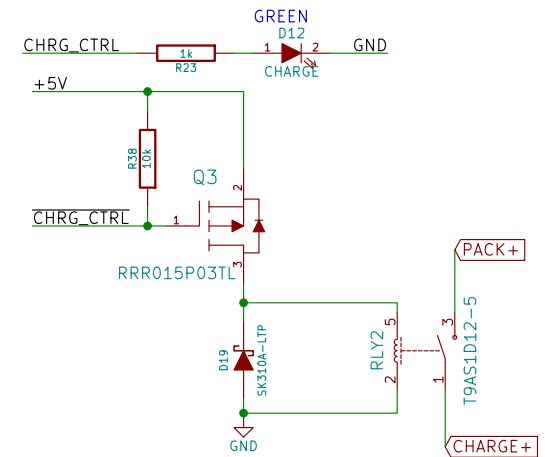

DEVELOPMENT ONLY

Engineer: Preston Bejabeng
 Supervisor: Christopher Nadovich
 Fall Semester 2016

Lafayette College

Sheet: /Safety Loop Wiring/
 File: safety_loop.sch

Title: Battery Pack Management Computer; L17-TSV-1

Size: USLetter Date: 2016-12-13

KiCad E.D.A. eeschema 4.0.2-stable

Rev: 0.8

Id: 3/6

GROUNDING LOW VOLTAGE

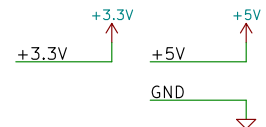

CANTXD — CANTX
 CANRXD — CANRX

CAN TRANCEIVER

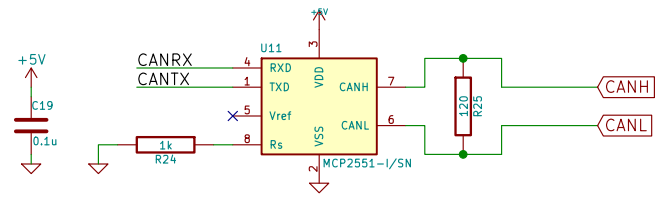

NOTE: DO NOT populate R25.
 R25 provides the ability to use this board as a terminating CAN node in development only.

DEVELOPMENT ONLY		
Engineer: Preston Bejabeng		
Supervisor: Christopher Nadovich		
Fall Semester 2016		
Lafayette College		
Sheet: /CAN Transceiver/		
File: can_xcvr.sch		
Title: Battery Pack Management Computer; L17-TSV-1		
Size: USLetter	Date: 2016-12-13	Rev: 0.8
KiCad E.D.A.	eeschema 4.0.2-stable	Id: 4/6

GROUNDING LOW VOLTAGE

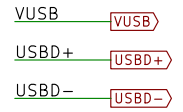
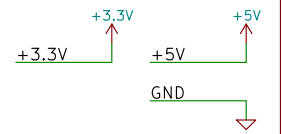

USB UART

This is an FTDI USB Serial Converter IC, it can be used to upload code, configure the device, or transfer debugging information if the software is configured properly.

Drivers available for Windows, Mac OS & Linux

USB BOOTSTRAP POWER

This diode is used to power the PACMAN computer board when the battery pack has been fully discharged. If voltage is not present between PACK+ and PACK-, then this diode will allow the USB port to supply up to 500mA of sustained current. For periods less than 0.1 seconds, 1A can be drawn.

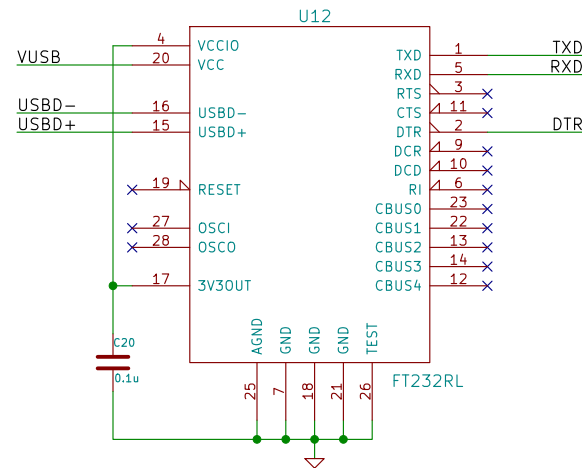

FTDI Reset Connection



DEVELOPMENT ONLY

Engineer: Preston Bejabeng
Supervisor: Christopher Nadovich
Fall Semester 2016

Lafayette College

Sheet: /FTDI USB UART/
File: ftdi_uart.sch

Title: Battery Pack Management Computer; L17-TSV-1

Size: USLetter Date: 2016-12-13
KiCad E.D.A. eeschema 4.0.2-stable

Rev: 0.8
Id: 5/6

HIGH VOLTAGE

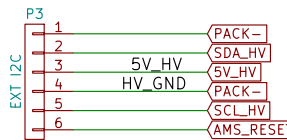
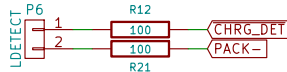
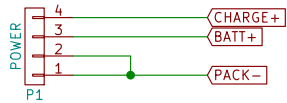

A jumper in the Anderson charge connector pulls an input low on the HV I2C expander, corresponding to either charge or low current output.

This RJ11 (RJ12 with center four pins utilized) connected allows the BBM-01 current sensor to connect to the board.

USB UART

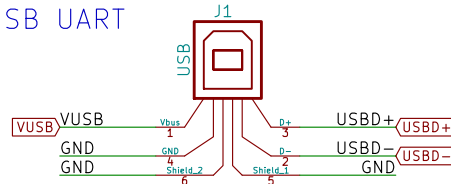

PACK WIRING HARNESS APPLICATION NOTE

Port J2 is a DB-37 backplane connector, which will be connected to the pack wiring harness via solder pot connections. The wiring of this connector, and its inputs/outputs are described in more detail in the pack wiring diagram.

GPIO HEADER

0.1" IDC Connector
External User Interface Board

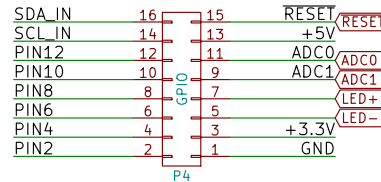

This connector contains pins for I2C communication with the LCD screen, input from control panel push buttons, and to illuminate the pack alle LED. If, at a later time, more complicated LCDs, or more I/O is required these pins can be utilized.

I2C PULLUP

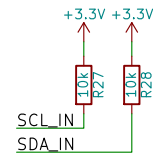

AVR DEBUGGING

JTAG Programming/Debug Header

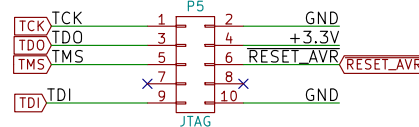

GROUNDING LOW VOLTAGE

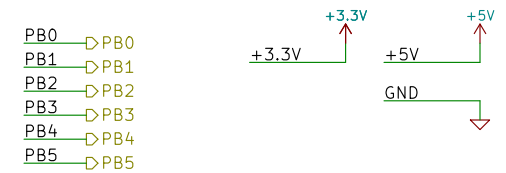

SAFETY LOOP A/B

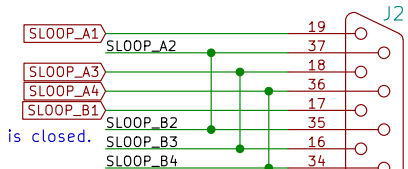

SLOOP_A1 and SLOOP_B1 pins are shorted together only when the safety loop is closed.

Pins in these sections are connected to obsolete signals in the test stand. They may be used, but the test stand must be updated as well.

FAN

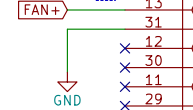

GLV HARNESS

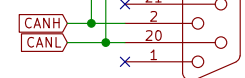

DEVELOPMENT ONLY

Engineer: Preston Bejabeng
Supervisor: Christopher Nadovich
Fall Semester 2016

Lafayette College

Sheet: /External Connectors/
File: connectors.sch

Title: Battery Pack Management Computer; L17-TSV-1

Size: USLetter Date: 2016-12-13

Rev: 0.8

KiCad E.D.A. eeschema 4.0.2-stable

Id: 6/6